

# LASER

## Analog Laser Displacement Transducer



### LAS Series

#### Key-Features:

- Available measurement ranges: 10 to 800 mm
- Resolution up to 2  $\mu\text{m}$ , linearity up to  $\pm 6 \mu\text{m}$
- Spot and line laser versions
- Individual parametrization by teach-in procedure
- Protection class: IP67
- Working temperature: 0 to 50 °C
- Very precise distance measurement on most materials
- Protected against reverse polarity and short circuit
- Analog output 4..20 mA and/or 0...10 V

#### Content:

<b>Measurement Principle &amp; Installation</b>	....2
<b>Overview of the Series</b>	....3
<b>Technical Data</b>	....4
<b>Technical Drawing</b>	....7
<b>Linearity &amp; Resolution</b>	....8
<b>Order Code</b>	..11
<b>Accessories</b>	..12

## INTRODUCTION

LAS laser sensors cover measurement ranges from 1 to 800 mm. The integrated micro-controller delivers an accurate output signal, which is proportional to the detected distance. External analysers to evaluate the signals are not required. Reliable operation, independent of color or other influences of the surface, is ensured by sophisticated electronic elements integrated in the system. The small visible laser spot allows a simple and precise orientation of the sensor. Distances to rough surfaces can be measured by using a fine laser line instead of the spot.

## MEASURING PRINCIPLE

The triangulation principle is basic for this measurement method. The laser beam in the form of a small spot arrives on the surface of the target, while the detector of the system captures its position. The distance itself is calculated by means of the change of the angle. Achievable resolution and accuracy are therefore influenced mainly by the distance  $d$ : In proximity of the sensor, a large angular change  $a_1$  can be obtained, whereas larger values result in a smaller angle  $a_2$ , thus in reduced accuracy (see drawing).

A photo diode array integrated in the sensor represents the receiver, high speed versions use a PSD element. The receiver is directly coupled to a micro-controller, being part of the system. This micro-controller analyses the light distribution on the element, calculates the exact angle and out of it the distance to the object. The calculated distance is either transferred to a serial port or alternatively is converted to a proportional output current. The micro-controller guarantees a very high linearity and accuracy. The combination of photo diode array and micro-controller allows a suppression of interfering reflections and ensures a reliable results even on most critical surfaces.

The sensor automatically adapts to the surface colour by a change of its internal sensitivity. This way influences due to the target colour are nearly excluded.

An integrated digital output is activated whenever the sensor does not receive enough light (pollution signal), or if no object within the measuring range can be detected at all.

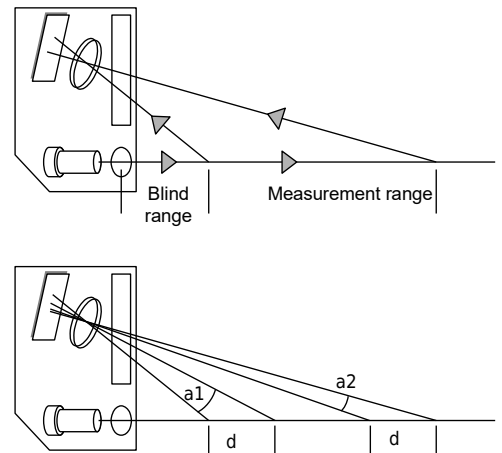

## INSTALLATION

### Spot laser

The object is sampled by a focussed laser beam. This version is the most preferred within the LAS series.

### Line laser

The laser beam is expanded to a fine line, by means of a deflection unit. Typical applications for sampling a target with a line laser are the position or thickness measurements of objects with rough, uneven, porous or interrupted surfaces.

### Teach-in function

The desired range can conveniently be adapted within the maximum measurement range by means of the teach-in line or button. The analog output has its full stroke within the teach-ed range. The default configuration uses the maximum measurement range. A separate description of the teach-in procedure is available upon request.

### Installation

The first condition for a successful distance measurement is the absence of any obstruction in the light path, as shown in fig. 3. The receiver optics must be able to detect the light spot directly (fig. 1 and 2).

For highly polished or mirror-like objects it is important to keep the direct reflection away from the detector. In these cases, it is recommended to slightly tilt the sensor (fig. 4).

Optimum results are obtained by transverse installation of the sensor with respect to the target movement (fig. 5).

For triangulation sensors, there is a simple rule, that the distance between sensor and target should be as small as possible. The smaller the working range the better the linearity and accuracy.

Electromagnetic compatibility: The sensor must correctly be grounded, a shielded cable is recommended.

### Cleaning of the laser window

- 1) dry cleaning with a soft brush
- 2) cleaning with a dry, soft, antistatic cloth
- 3) wet cleaning with clear water, approx. 30 degree Celsius, if necessary with a little mild soap.

Please do NOT use window cleaner!!

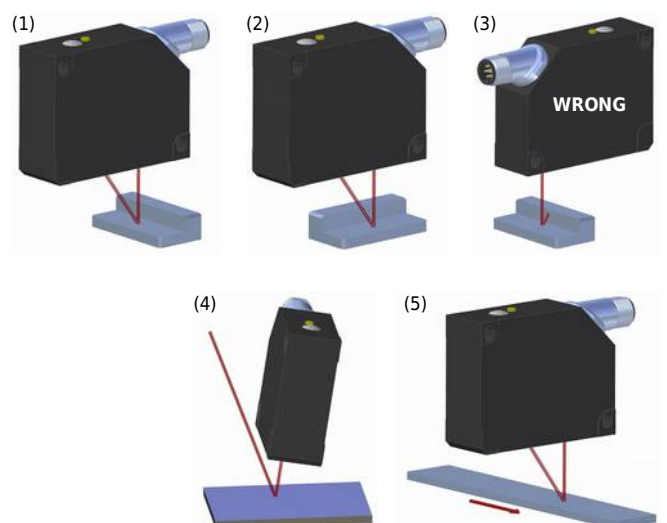
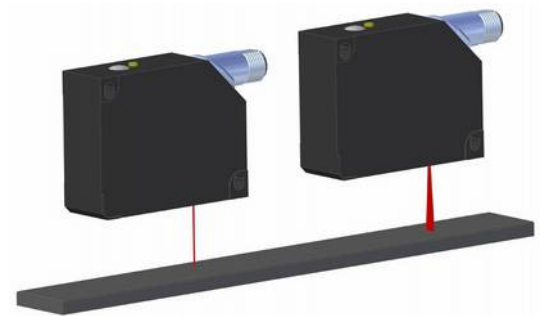

## OVERVIEW OF THE LAS SERIES

		LAS-TM	LAS-TML	LAS-TB	LAS-T/TL	LAS-T5
Smallest working range within the series *	[mm]	16	50	50	200	30
Largest working range within the series **	[mm]	550	550	200	1000	600
Smallest measurement range within the series	[mm]	10	300	10	800	40
Largest measurement range within the series	[mm]	500	500	100	800	500
Measuring range teachable		▪	▪	▪	▪	▪
Smallest linearity error within the series	[mm]	±0.006	±0.05	<0.045	±0.011	±0.012
Best resolution within the series	[mm]	0.002	0.010	<0,015	0.020	0.004
Highest sampling rate within the series	[ms]	<0.9	<0.9	<2	<4	<0.9
Spot laser		▪			LAS-T	▪
Line laser			▪	▪	LAS-TL	
Laser class		2	2	1	2	2
Output signal 0...10 V		▪	▪	▪		▪
Output signal 4...20 mA		▪	▪	▪		▪
Output signal 0...10 V and 4...20 mA					▪	
Alarm output					PNP	
Connector M8, 4-pole		▪	▪	▪		
Connector M12, 5-pole						▪
Connector M12, 8-pole					▪	
Special properties		Very compact		Applicable for mat black surfaces		Outstanding price-performance ratio

\* corresponds to the blind range of the sensor

\*\* corresponds to the blind range + the measurement range

## CONNECTION LAS-T / LAS-TL

### Electrical connection LAS-T/ LAS-TL

PIN	Cable colour K8P..	Function
1	white	n. c.
2	brown	V +
3	green	4...20 mA
4	yellow	Teach-in
5	grey	Alarm
6	pink	0...10 V
7	blue	GND
8	red	Synchro-in

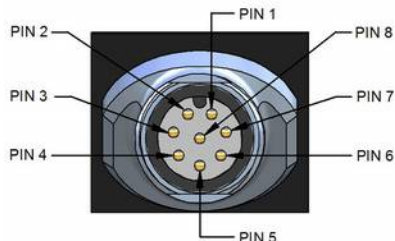

### Alarm output

The alarm output is activated, as soon as the object is outside of the measurement range, or if the received signals are useless for a distance measurement (too low, or too high). In both cases the analog output signal is 4 mA / resp. 0 V.

The sensor has no internal hold function to bridge missing measurement signals. Therefore it may happen in critical applications (extremely bright surfaces) that the output shortly drops to 4 mA / resp. 0V, when the measurement signal gets lost. By checking the status of the alarm output before making a measurement, this false output signal can be identified.

# TECHNICAL DATA – LAS-TM / LAS-T SERIES

**LAS-TM:** Very compact design  
Measurement range teachable  
Type of analog output:  
4...20 mA or 0...10 V

**LAS-T/TL:** Dual analog output:  
4...20 mA and 0...10 V  
Measurement range teachable  
Synchronization input  
Alarm output



Spot laser		LAS-TM-10	LAS-TM-104	LAS-TM-300	LAS-TM-500	LAS-T-800
Line laser				LAS-TML-300	LAS-TML-500	LAS-TL-800
Measurement range	[mm]	16...26	16...120	50...350	50...550	200...1000
Resolution *	[mm]	0.002...0.005	0.002...0.12	0.01...0.40	0.01...1.15	0.02...0.4
Linearity error *	[mm]	±0.006...0.015	±0.015...0.35	±0.05...1.2	±0.08...3.5	±0.11...1.65
Min. teach-in range	[mm]	>1	>2	>5	>10	>10
Response time	[ms]	< 0.9	< 0.9	< 0.9	<2	< 4
Sensor element		Photo diode array				
Alarm output		-	-	-	-	PNP****
Power-ON indicator		LED green				
Alarm indicator		LED red				
Pollution indicator		LED red flashing				
Supply	[VDC]	12...28				
Max. current consumption	[mA]	100		80		100
Load resistance	[Ω]	4...20 mA: <300, 0...10 V: >100 k				
Light source		Laser diode red, pulsed				
Laser class		2				
Wavelength	[nm]	650				
Safety features		yes / yes				
Housing material		Zinc diecasting		Aluminium	Aluminium	Aluminium
Protection class		IP67				
Working temperature	[°C]	0...50				
Connection		M8 connector, 4 poles				M12 connector, 8 poles
Beam diameter spot laser	[mm]	0.5...0.2	0.9...0.5	1	1	2
Beam type, line laser ***		-	-			
Beam height	[mm]	-	-	4.0...9.0	4.0...11.0	6...20
Width	[mm]	-	-	2	2.0...1.0	02.05.15
Output signal **		4...20 mA or 0...10 V **				4...20 mA and 0...10 V

\* Values for linearity and resolution are given for a mat white reference surface.

\*\* Type of analog output (4...20 mA or 0...10 V) has to be specified when ordering.

\*\*\* The detector calculates an optical (not a mathematical) averaging of the sampled surface, i.e. a kind of a surface integral.

\*\*\*\* Binary open collector switching output with PNP transistor switching to +Vs. Consequently the load current flows from the switching output through the load resistance to 0 V. A suppressor diode is integrated and also an internal load resistor of approx. 10 kOhm ... 50 kOhm for measurement purposes.

## Electrical connection LAS-TM, LAS-TML, (LAS-T/TL see page 3)

PIN	Function
1	V +
2	Teach-in
3	GND
4	Signal +

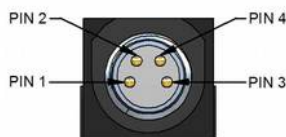

## Connection cable

### Cable with M8 mating connector

K4P2M-S-M8 2 m, straight connector, 4 pole, shielded

K4P5M-S-M8 5 m, straight connector, 4 pole, shielded

### PIN Cable colour

1	brown
2	white
3	blue
4	black

## TECHNICAL DATA – LAS-TB SERIES

LAS-TB: Line laser  
 Made for mat black surfaces  
 Measurement range teachable  
 Type of analog output:  
 4...20 mA or 0...10 V

Line laser		LAS-TB-10	LAS-TB-40	LAS-TB-100
Measurement range	[mm]	50...60	60...100	100...200
Resolution *	[mm]	<0.015	0.015...0.038	0.039...0.15
Linearity error *	[mm]	<0.045	±0.047...0.118	±0.123...0.457
Min. teach-in range	[mm]	>1	>4	>5
Response time	[ms]		<2	
Sensor element		Photo diode array		
Alarm output		-		
Power-ON indicator		LED green		
Alarm indicator		LED red		
Pollution indicator		LED red flashing		
Supply	[VDC]	12...28		
Max. current consumption	[mA]	80,0		
Load resistance	[Ω]	4...20 mA: <300, 0...10 V: >100 k		
Light source		Laser diode red, pulsed		
Laser class		1		
Wavelength	[nm]	650		
Safety features		yes / yes		
Housing material		Aluminium		
Protection class		IP67		
Working temperature	[°C]	0...50		
Connection		M8 connector, 4 poles		
Beam type, line laser ***	[mm]	0.1...0.18	0.11...0.45	0.2...0.74
Beam height	[mm]	1.1	1.7	2.8...3.7
Width	[%]	>0.5	>0.8	>2
Output signal **		4...20 mA or 0...10 V		

\* Values for linearity and resolution are given for a mat white reference surface.

\*\* Type of analog output (4...20 mA or 0...10 V) has to be specified when ordering.

\*\*\* The detector calculates an optical (not a mathematical) averaging of the sampled surface, i.e. a kind of a surface integral.

### Electrical connection LAS-TB

PIN	Function
1	V +
2	Teach-in
3	GND
4	Signal +

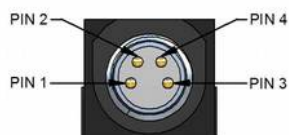

### Connection cable

#### Cable with M8 mating connector

K4P2M-S-M8	2 m, straight connector, 4 pole, shielded
K4P5M-S-M8	5 m, straight connector, 4 pole, shielded

#### PIN Cable colour

1	brown
2	white
3	blue
4	black

## TECHNICAL DATA – LAS-T5 SERIES

**LAS-T5:** Low-cost series for conventional applications.  
 Measuring range teachable.  
 Type of analog output: 4...20 mA or 0...10 V



		LAS-T5-40	LAS-T5-100	LAS-T5-250	LAS-T5-500
Measuring range	[mm]	30...70	30...130	50...300	100...600
Resolution *	[mm]	0.004...0.02	0.005...0.06	0.01...0.33	0.015...0.67
Linearity error *	[mm]	±0.012...0.06	±0.015...0.2	±0.03...1	±0.05...2
Minimum Teach-in-range	[mm]	>2	>3	>5	>10
Response time	[ms]	< 0.9			
Sensor element		Photo diode array			
Power ON indicator		LED green			
Alarm lamp		LED red			
Pollution indicator		LED red, flashing			
Supply	[VDC]	12...28			
Max. current consumption	[mA]	100			
Load resistance	[Ω]	4...20 mA: <300, 0...10 V: >100 k			
Light source		Laser diode red, pulsed			
Laser class		2			
Wavelength	[nm]	650			
Safety features		Protection against reverse polarity and short circuit			
Housing material		Zinc diecasting			
Protection class		IP67			
Working temperature	[°C]	0...50			
Connection		M12 plug, 5-pole			
Beam diameter spot laser	[mm]	1...0.2	2...1	2.0	2.0
Analogue output **		4...20 mA, 0...10 V			

\* Values for linearity and resolution are given for a mat white reference surface.

\*\* Type of analog output (4...20 mA or 0...10 V) has to be specified when ordering.

### Electrical connection LAS-T5

PIN	Function
1	V +
2	Signal
3	GND
4	n. c.
5	Teach-in

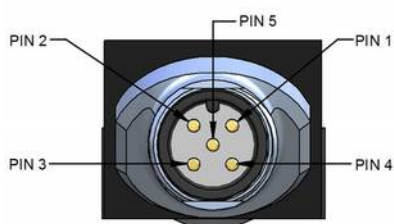

### Connection cable

#### Cable with M12 connector, 5 pole, shielded, IP67

K5P2M-S-M12	2 m, M12 connector straight
K5P5M-S-M12	5 m, M12 connector straight
K5P10M-S-M12	10 m, M12 connector straight
K5P2M-SW-M12	2 m, M12 connector angular
K5P5M-SW-M12	5 m, M12 connector angular
K5P10M-SW-M12	10 m, M12 connector angular

PIN	cable colour
1	brown
2	white
3	blue
4	black
5	grey

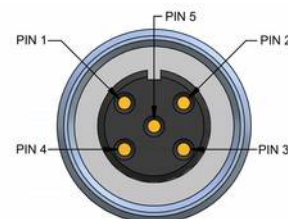

# TECHNICAL DRAWING

LAS-TM-10 / LAS-TM-104

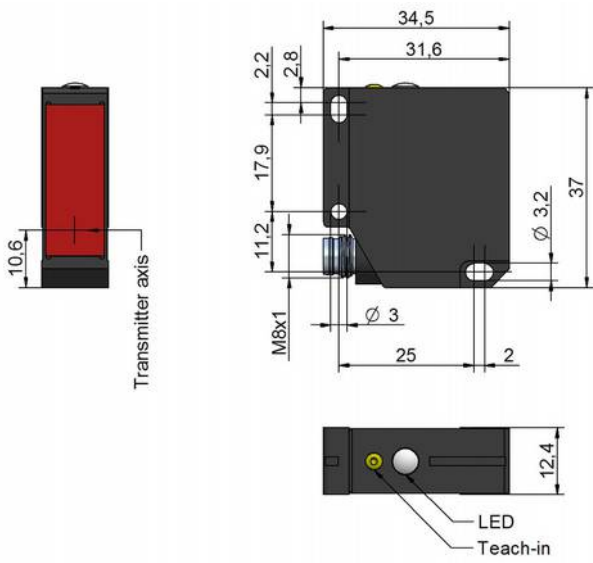

LAS-TM-300 / LAS-TM-500 / LAS-TB-10 / LAS-TB-40 / LAS-TB-100

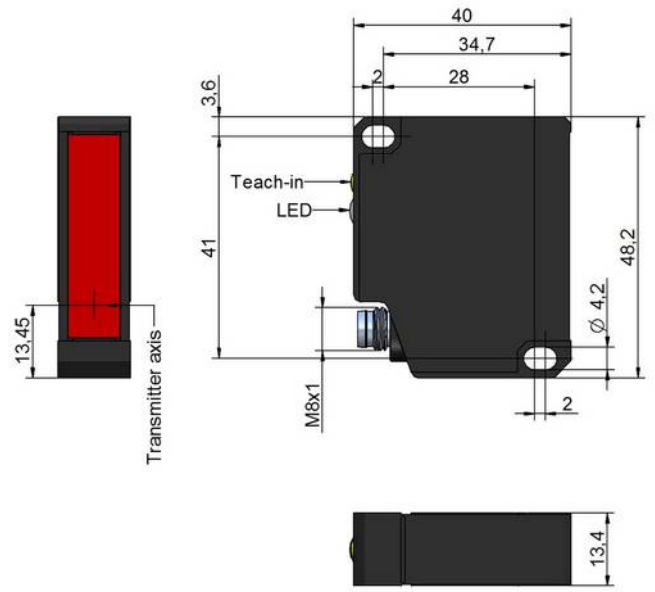

LAS-T5-40...500

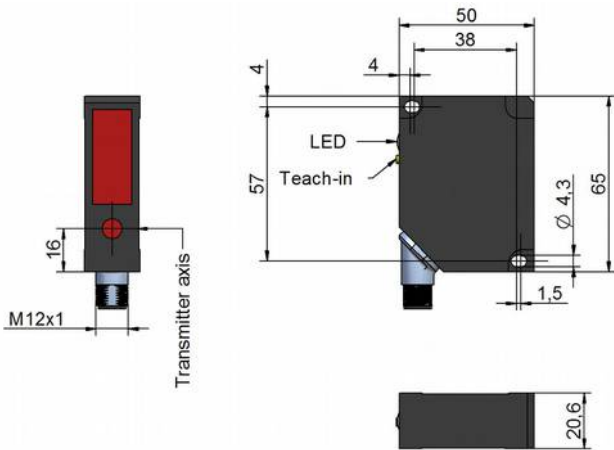

LAS-T-800 / LAS-TL-800

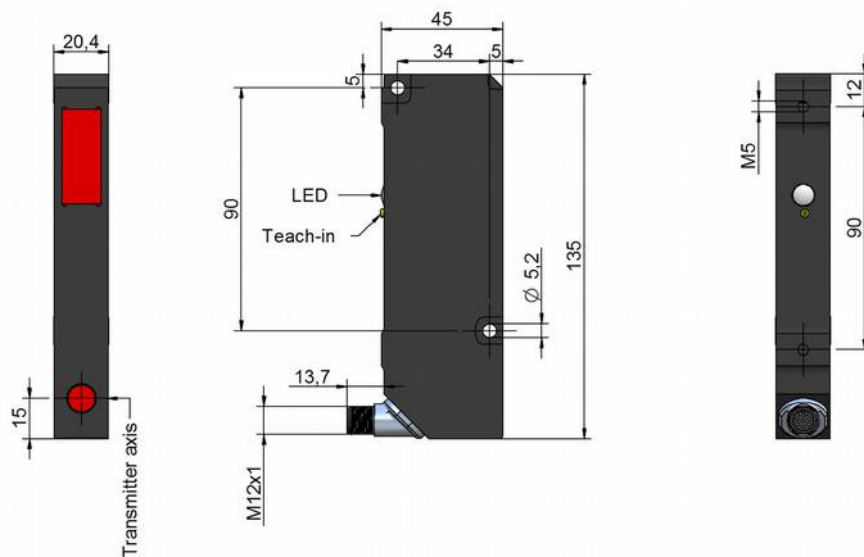

# LINEARITY / RESOLUTION - LAS-TM / LAS-T SERIES

When teaching the measurement range, it is recommended always to select the smallest possible range, because this way the resolution is increased and the linearity error decreased. Also keep in mind that the distance between sensor and target should be as small as possible.

## LAS-TM-10

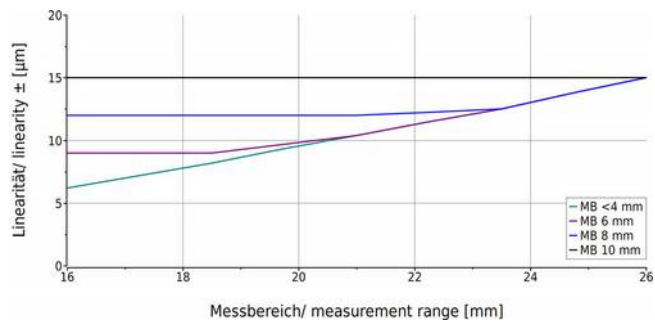
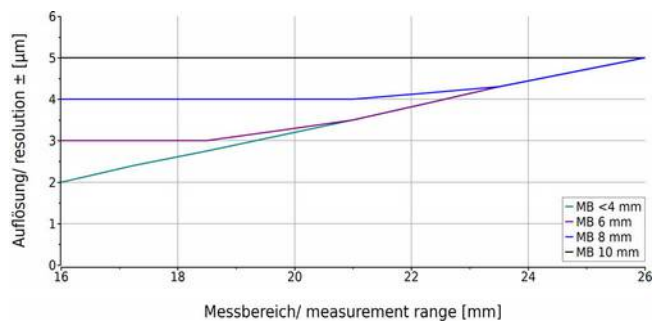

## LAS-TM-104

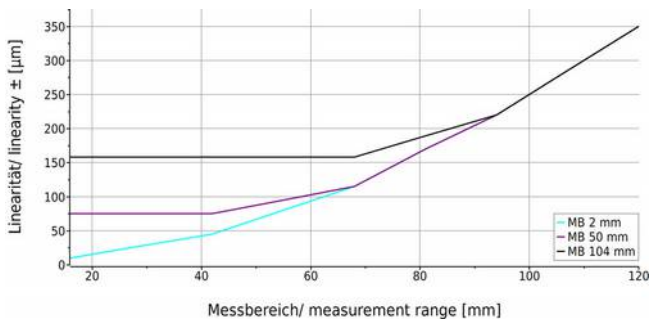
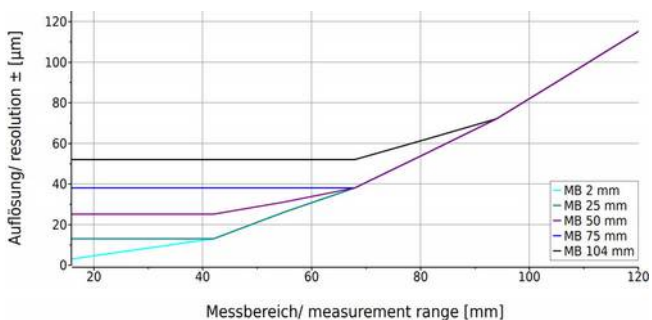

## LAS-TM-300

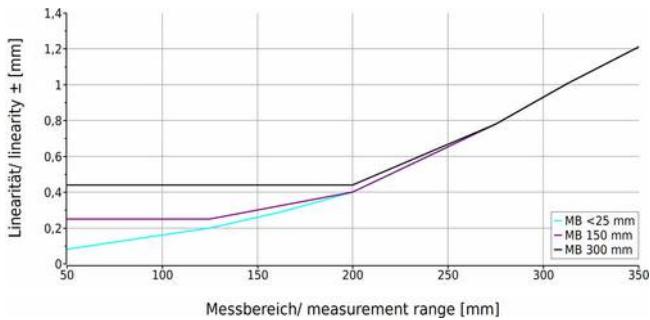
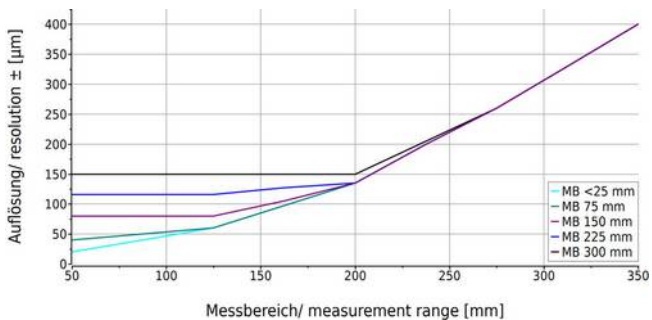

## LAS-TM-500

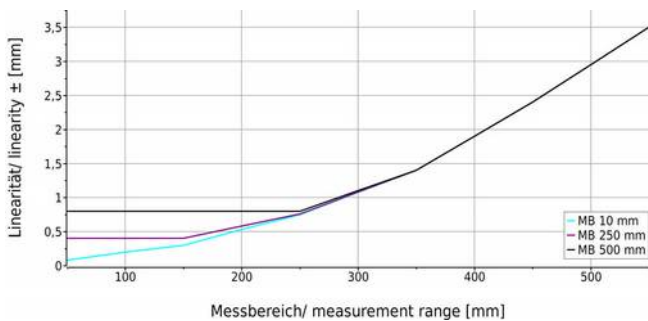
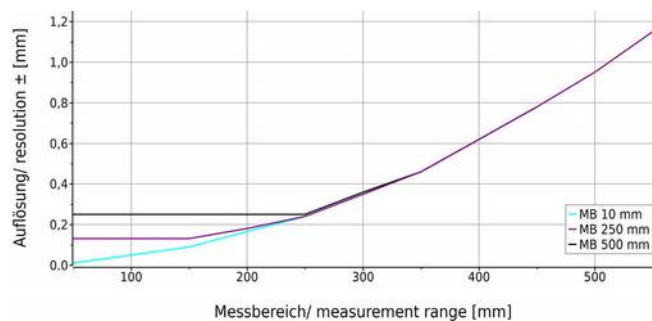

## LAS-T-800

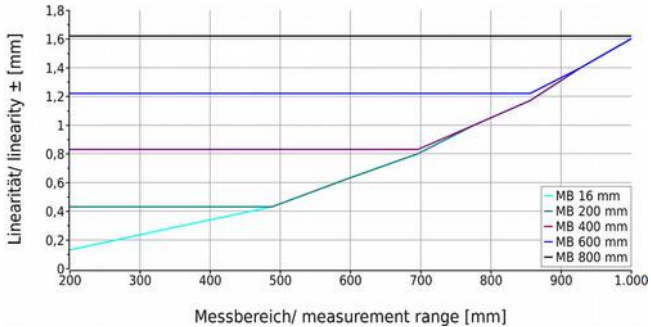
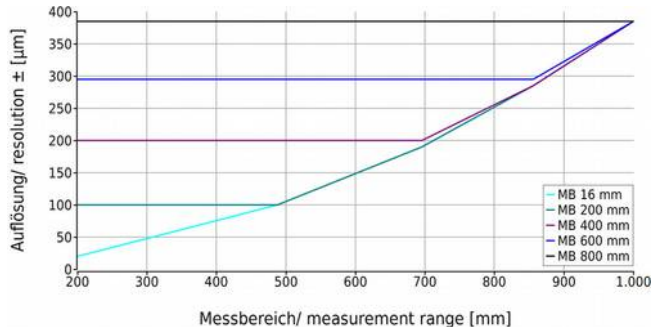

MB stands for teached measurement range.



## LINEARITY / RESOLUTION - LAS-TB SERIES

When teaching the measurement range, it is recommended always to select the smallest possible range, because this way the resolution is increased and the linearity error decreased. Also keep in mind that the distance between sensor and target should be as small as possible.

### LAS-TB-10

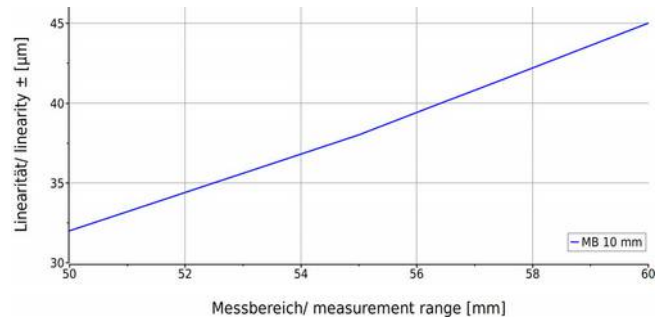
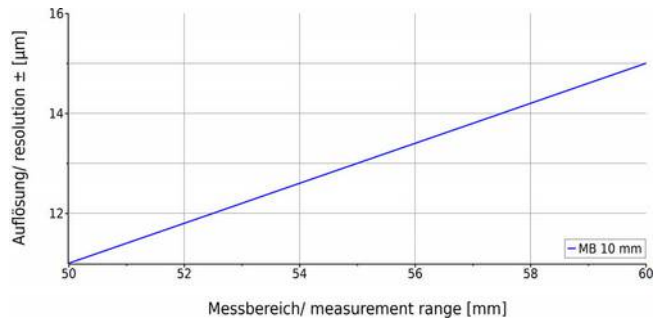

### LAS-TB-40

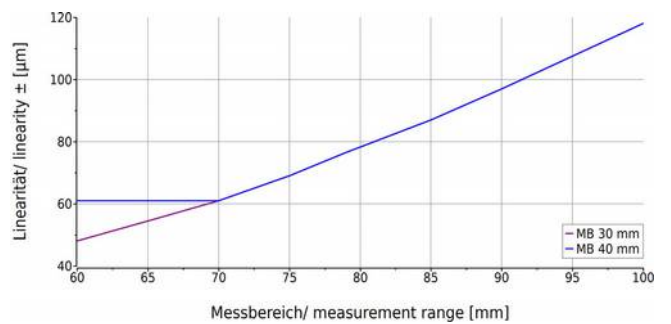
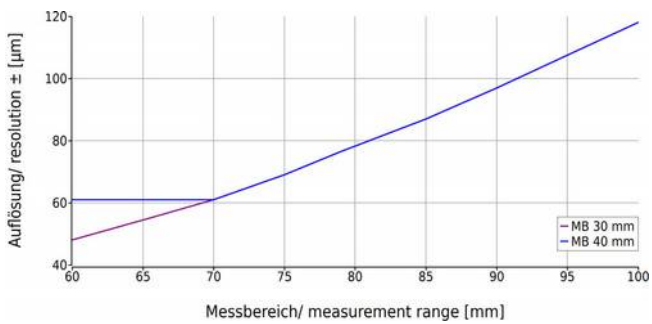

### LAS-TB-100

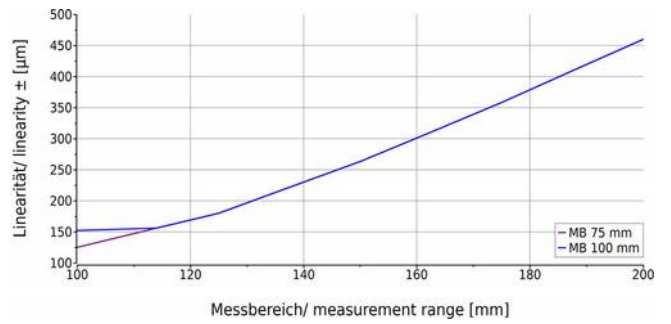
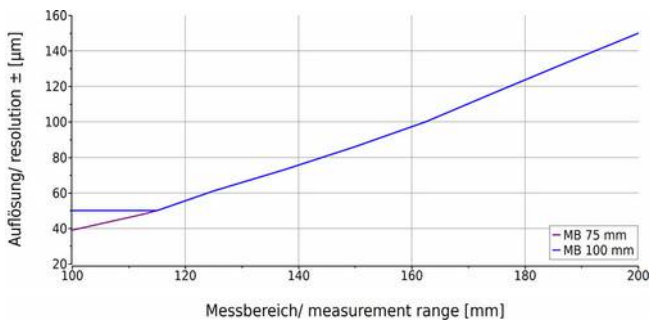

MB stands for teached measurement range.

# LINEARITY / RESOLUTION - LAS-T5 SERIES

When teaching the measurement range, it is recommended always to select the smallest possible range, because this way the resolution is increased and the linearity error decreased. Also keep in mind that the distance between sensor and target should be as small as possible.

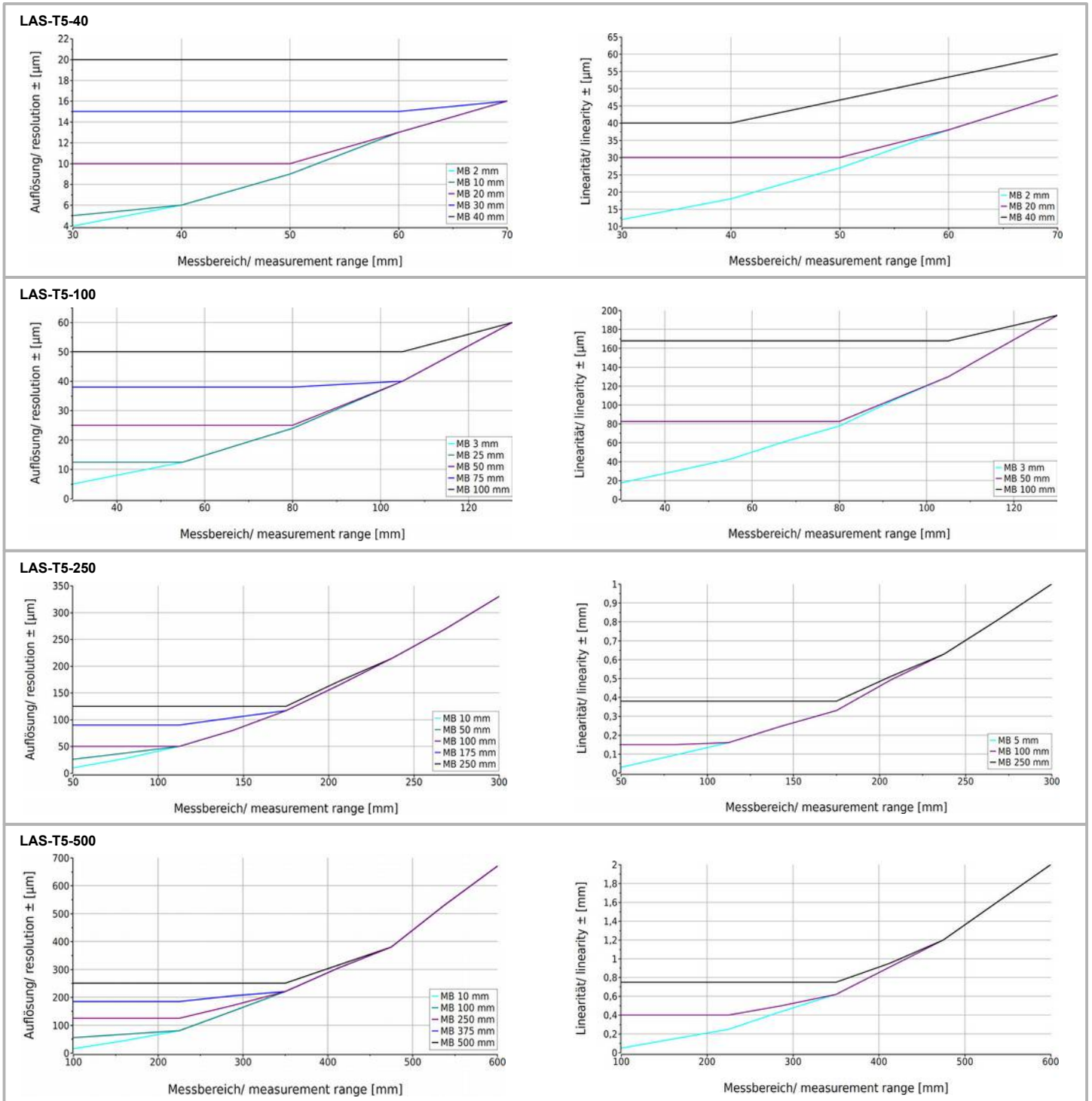

MB stands for teached measurement range.

**ORDER CODE LAS-TM / LAS-TML / LAS-TB**

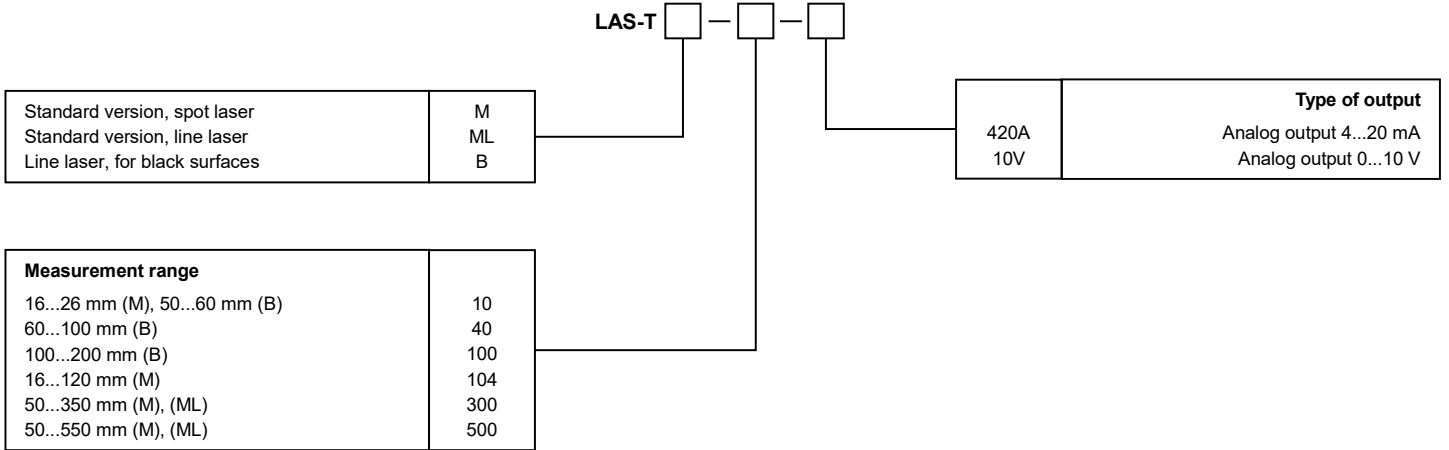

**ORDER CODE LAS-T / LAS-TL**

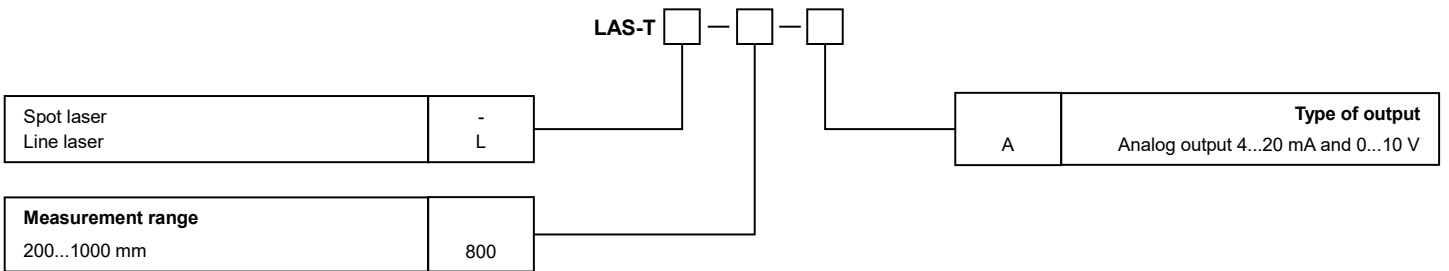

**ORDER CODE LAS-T5**

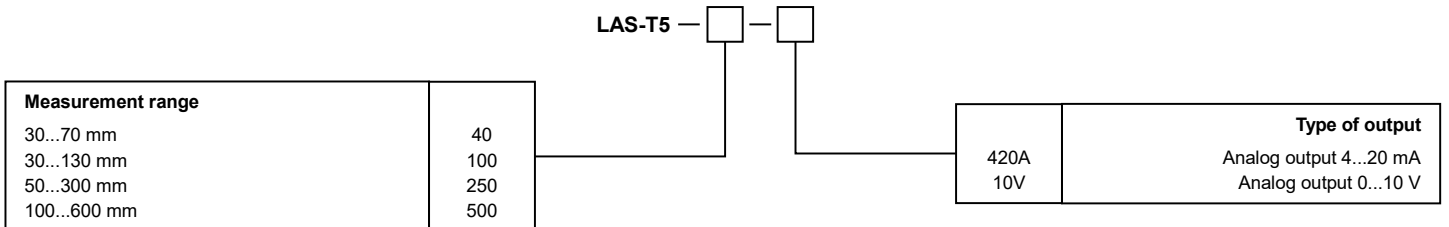

## ACCESSORIES

### Connection cable, 5 pole, shielded, with mating M12 connector for LAS-T5 series

K5P2M-S-M12	2 m, connector straight
K5P5M-S-M12	5 m, connector straight
K5P10M-S-M12	10 m, connector straight
K5P2M-SW-M12	2 m, connector angular
K5P5M-SW-M12	5 m, connector angular
K5P10M-SW-M12	10 m, connector angular

### Connection cable, 8 pole, shielded, with mating M12 connector for LAS-T/TL series

K8P2M-S-M12	2 m, connector straight
K8P5M-S-M12	5 m, connector straight
K8P10M-S-M12	10 m, connector straight
K8P2M-SW-M12	2 m, connector angular
K8P5M-SW-M12	5 m, connector angular
K8P10M-SW-M12	10 m, connector angular

### Connection cable, 4 pole, shielded, with mating M8 connector for LAS-TM / LAS-TML / LAS-TB series

K4P2M-S-M8	2 m, connector straight
K4P5M-S-M8	5 m, connector straight

### Protection glass for series LAS-T5, LAS-T/TL (only up to 500 mm FS)

Schutzglas-LAS	self-adhesive
----------------	---------------

### Digital display 1 channel, 0...10V/4...20 mA

PAXP000B	1 channel, supply: 85 to 250 VAC
PAXP001B	1 channel, supply: 11...36 VDC/24 VAC

### Digital display 2 channels, 0...10V/4...20 mA

PAXDP00B	2 channels, supply: 85 to 250 VAC
PAXDP01B	2 channels, supply: 11...36 VDC/24 VAC

For further information please see the separate PAX data sheet



### General safety instructions

Attention radiation laser.

Do not stare into beam.

Do not point the laser beam towards someone's eye.

It is recommended to stop the beam by a matte object or matte metal shield.

Laser regulations require the power to the sensor be switched off when turning off the whole system this sensor is part off.

Subject to change without prior notice.

### WayCon Positionsmesstechnik GmbH

email: [info@waycon.de](mailto:info@waycon.de)

internet: [www.waycon.de](http://www.waycon.de)

### Head Office

Mehlbeerenstr. 4

82024 Taufkirchen / Germany

Tel. +49 (0)89 67 97 13-0

Fax +49 (0)89 67 97 13-250

### Office Cologne / Germany

Auf der Pehle 1

50321 Brühl

Tel. +49 (0)2232 56 79 44

Fax +49 (0)2232 56 79 45